

INGERSOLL WIND POWER
INGERSOLL ENERGIE EOLIENNE



INGERSOLL WERKZEUGE GMBH - THE COMPANY



Ingersoll Werkzeuge GmbH is specialized in the production of cutting tools with an excellent vibration-free performance in both standard and special-purpose design.

In addition to very successful solutions for heavy-duty milling and the project-oriented development of special cutting tool solutions, we offer a whole range of technology potential which is applied by the most various industries. The close cooperation with our customers for the development of technically demanding solutions for machining problems is the basis of long-term and durable partnerships – worldwide. Small as well as medium-sized companies but also international enterprises trust our professional qualification and profit from the reliability and process security of our cutting tools.

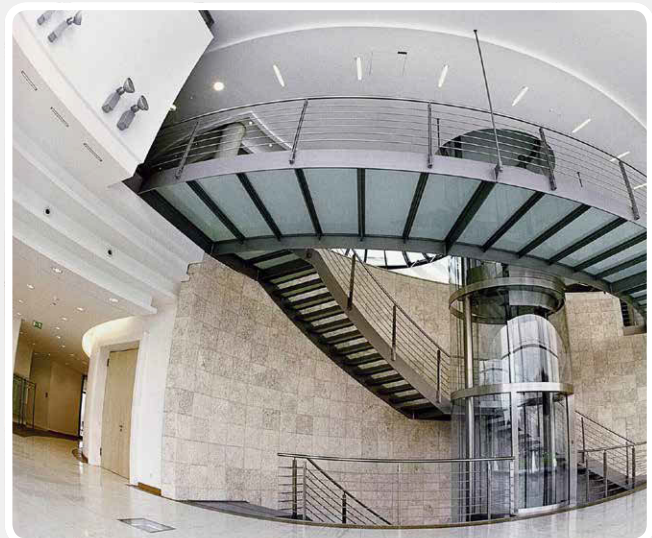



Ingersoll Werkzeuge GmbH est une entreprise spécialisée dans la fabrication d'outils coupants. Les produits standards et spéciaux sont très performants, particulièrement en matière de rigidité.

En plus de nos solutions innovantes pour le fraisage lourd et notre orientation vers le développement d'outils coupants spéciaux, nous offrons une gamme complète pouvant répondre aux technologies appliquées dans la plupart des industries. Travailler en étroite collaboration avec nos clients afin de développer des solutions techniques en matière de fraisage, est pour nous la base d'un partenariat durable, dans le monde entier. Notre professionnalisme ainsi que la fiabilité de nos outils et la sécurité de nos process sont reconnus à la fois par des petites et moyennes entreprises mais aussi par des groupes internationaux.



Ingersoll's standard program comprises a broad and worldwide established range of cutting tools, suitable for the most various applications.

This range of cutting tools is constantly expanded: End mills, shell end mills, shoulder-type milling cutters, face mills, slotting cutters, form milling cutters, indexable drills, solid carbide, adaptations, set-up equipment and indexable inserts. With a complete line of turning and engraving tools we can now offer our customers a new group of products, thus expanding our capabilities as a broad-range supplier. The development and production of special-purpose tools according to customer-specific requirements is another important factor for Ingersoll Werkzeuge GmbH. Our know-how and great potential of experience, combined with our own demand for quality, functionality and innovation, guarantees our customers the optimum cutting tool solution - for individual machining tasks, for all industries.





Le programme standard d'ingersoll se compose d'une gamme complète d'outils coupants reconnue au niveau international et adaptée à la plupart des usinages.

Cette gamme d'outils coupants se développe constamment: fraise à surfer, à dresser, à rainurer, 3 tailles, fraises de forme, attachements, moyens de réglage et plaquettes indexables. La seconde activité importante d'Ingersoll outils coupants est le développement et la fabrication d'outils spéciaux, réalisés selon la demande spécifique du client. Notre savoir faire ainsi que notre expérience, alliés à un souci de qualité, de fonctionnalité et d'innovation garantissent à nos clients des solutions optimales d'outils coupants pour tous les types d'usinage et d'industries.

■ TOTAL MACHINING SOLUTIONS FOR THE WIND POWER INDUSTRY



Wind power is a green technology that will potentially change the world's future energy requirements. Ingersoll is working at the forefront of this industry supporting wind turbine manufacturers with state-of-the-art cutting tools used to machine critical components.

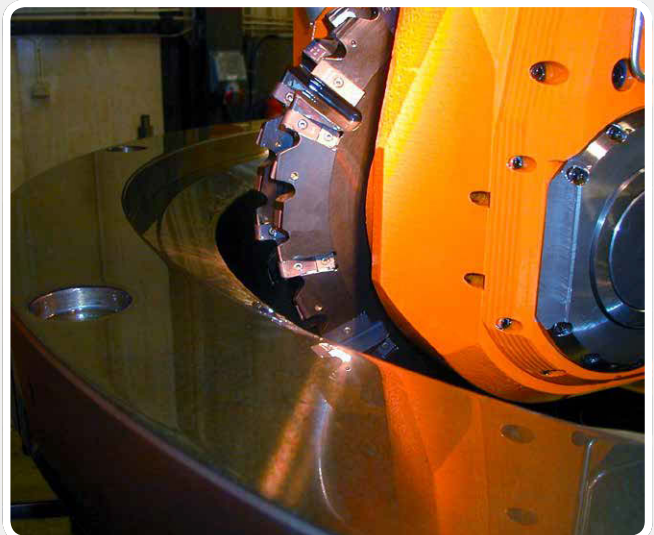

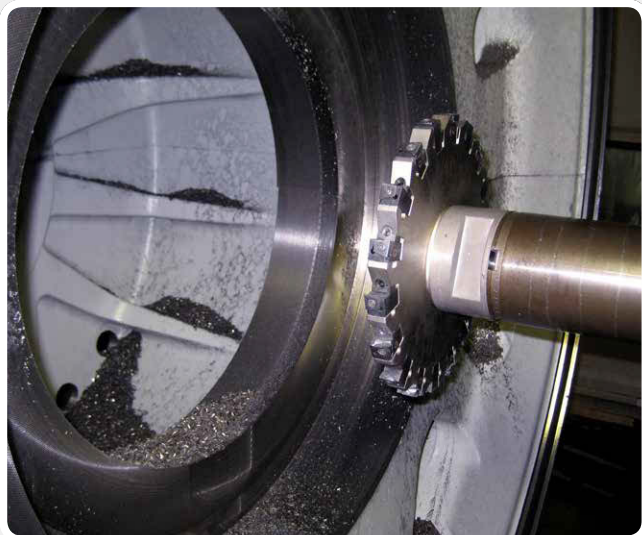

L'énergie éolienne est une technologie verte qui pourrait potentiellement changer les besoins futurs en énergie à travers le monde. Ingersoll est très présent dans ce type d'industrie et propose des outils performants pour l'usinage de ces composants difficiles.

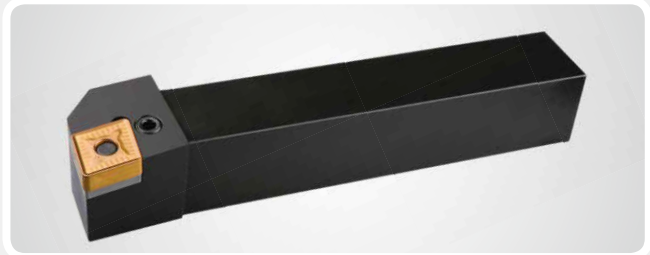

Ingersoll contributes to the supply of green energy through its vast experience and specialized technology that enables wind turbine producers to efficiently and productively manufacture components for wind turbines.

Ingersoll delivers remarkable cutting tools and production solutions which are used in the manufacture of gearboxes, tower flanges, main shafts, bearing housings and hubs as well as all the peripheral components. Ingersoll provides complete tooling solutions for heavy turning, milling and drilling to improve productivity and to cut the cost of production. Our machining specialists will fulfill your machining demands.



- 1 Rotor hub/Moyeu rotor
- 2 Blades/Pales
- 3 Main shaft/Structure
- 4 Gearbox/Boîtes de vitesse
- 5 Generator/Générateur

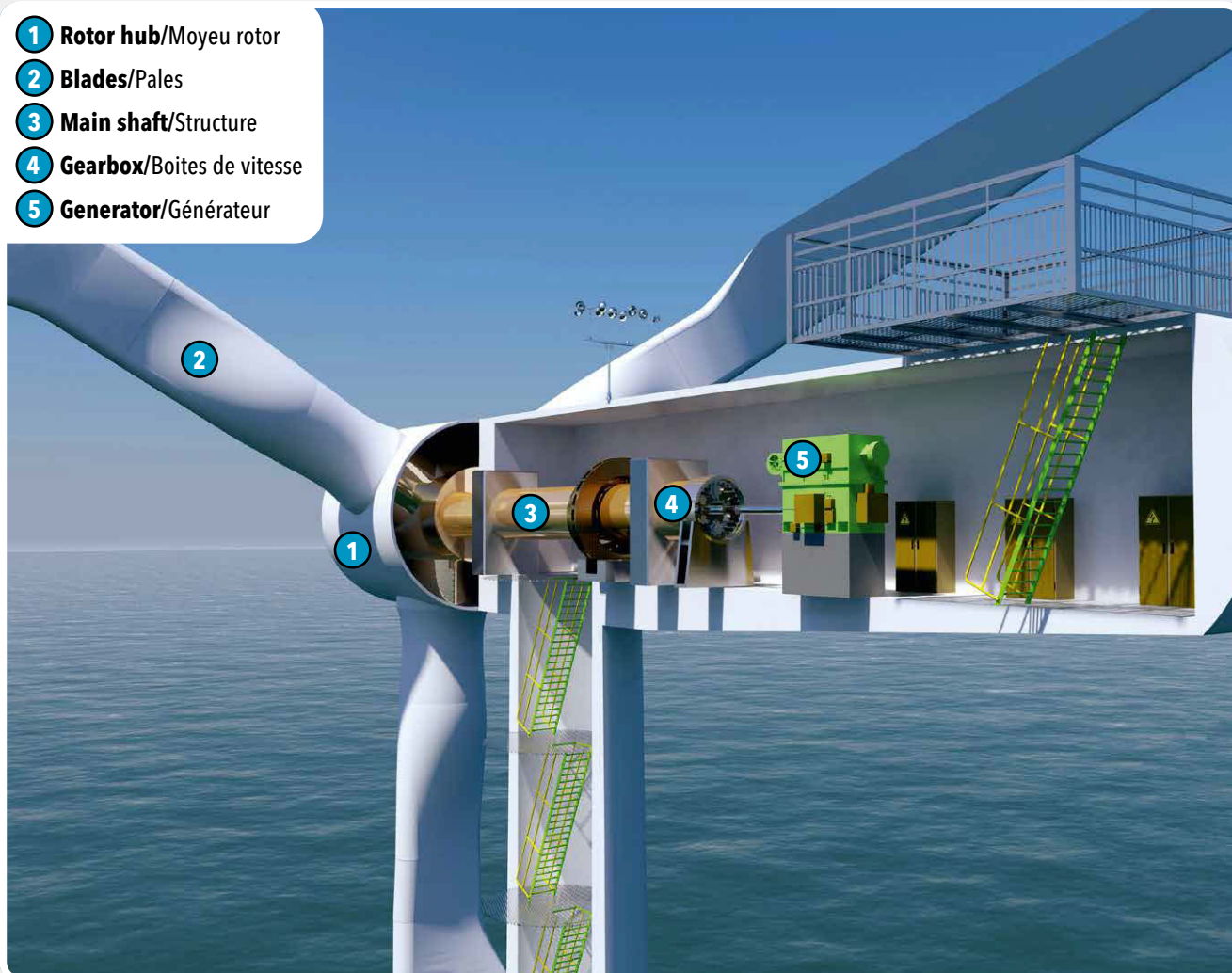

Ingersoll contribue à l'énergie verte grâce à une vaste technologie et une grande expérience permettant aux fournisseurs d'éoliennes une fabrication efficace et productive.

Ingersoll offre des outils coupants et des solutions dans la fabrication de boîtes de vitesses, les arbres principaux, les paliers et moyeux ainsi que pour tous les composants périphériques, Ingersoll fournit des solutions complètes d'outillage pour le tournage lourd, le fraisage et de perçage afin d'améliorer la productivité et de réduire le coût de production. Nos spécialistes sauront répondre à vos exigences d'usinage.



High productive milling solutions

Ingersoll's standard program comprises a broad and worldwide established range of cutting tools, suitable for the most various applications.

Tailor made cutters

Ingersoll manufactures tailor-made cutters that can achieve higher productivity and efficiency considering machine power and form of the workpieces.





Solutions de fraisage haute productivité

Le programme standard Ingersoll propose un large choix d'outils coupants pour les applications les plus diverses..

Fraises spéciales

Ingersoll fabrique des fraises spéciales qui permettent d'augmenter votre productivité et votre rendement suivant la puissance machine et la pièce à usiner.

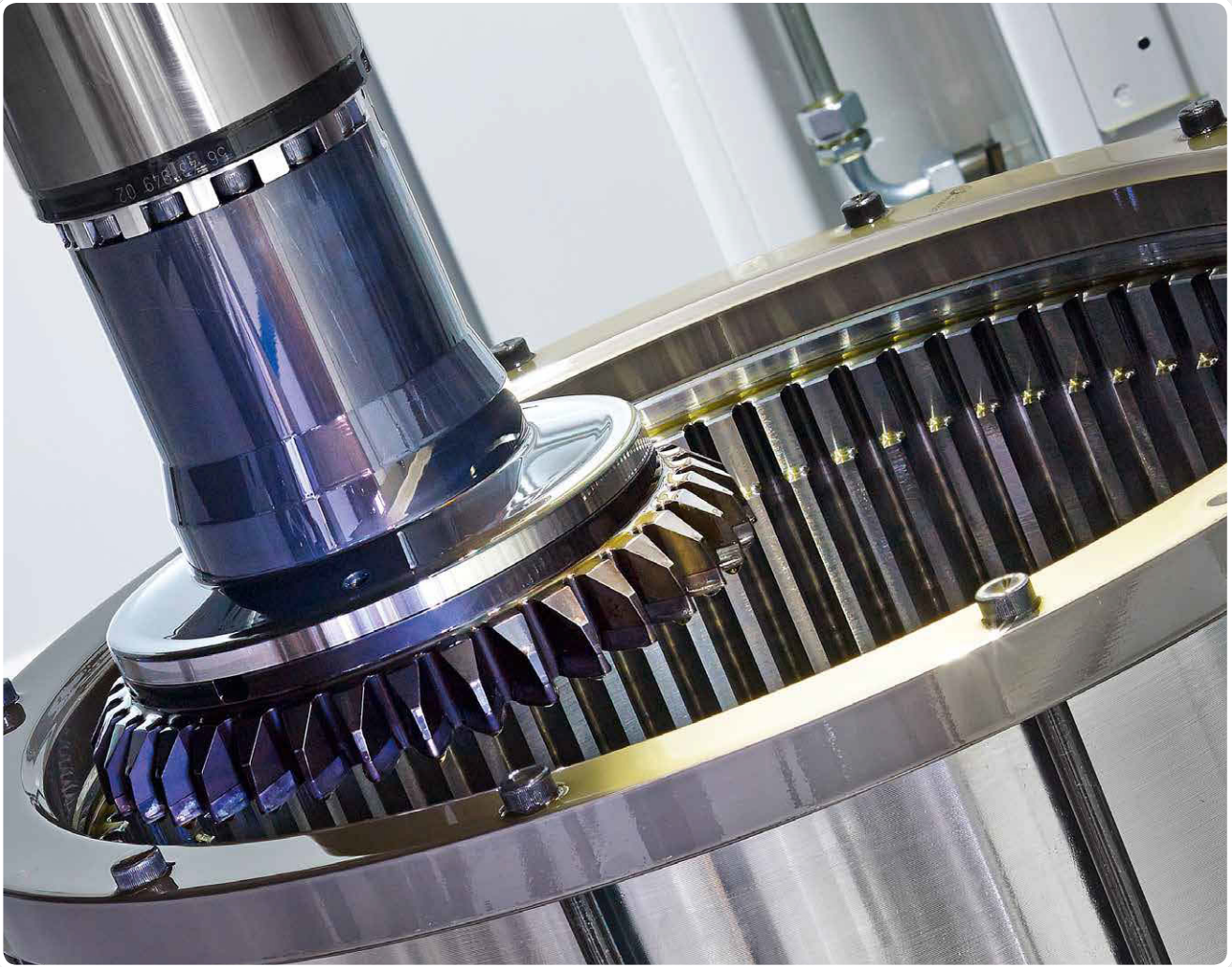

For more than 40 years Ingersoll has developed gear milling tools with indexable carbide inserts. During this period of time Ingersoll has produced numerous cutting tools, both in standard design as well as special design in accordance with the individual requirements of the customers, from module 1 up to module 100.

In order to meet the increasing demands in gear milling, the Ingersoll engineers develop new innovative cutting tool concepts and technologies in cooperation with our customers.

Ingersoll - a strong partner in gear milling!



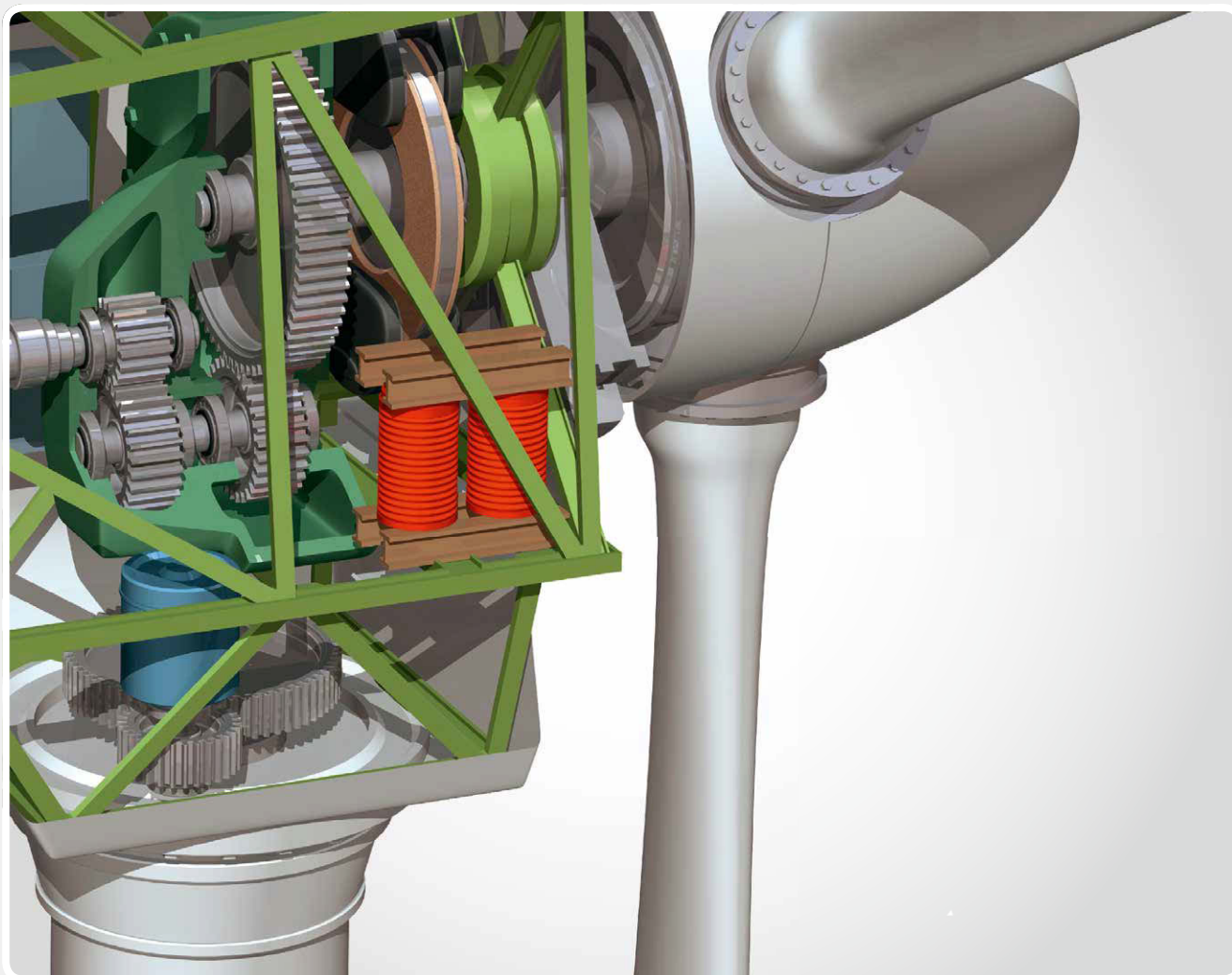

Depuis plus de 40 ans Ingersoll développe des outils de taillage à plaquettes carbure. Au cours de cette période Ingersoll a produit de nombreux outils coupants, à la fois en version standard mais également en version spéciale, conformément aux exigences des clients, à partir de module 1 jusqu'au module 100.

Afin de répondre aux demandes croissantes de fraisage, les ingénieurs Ingersoll ont développé de nouveaux concepts d'outils coupants et de technologies en coopération avec nos clients.

Ingersoll, un partenaire fort dans le taillage d'engrenages!

TOWER FLANGE, MAIN SHAFT & BEARING HOUSING



Ingersoll offer a large variety of solutions in the area of boring tools which make your production more effective. Whether there are standard or special-purpose solutions - with Ingersoll cutting tools you can look ahead into a successful future!

Also Ingersoll have a considerable know-how to ensure you constant machining conditions for turning operations. Use cutting tools from Ingersoll and find out about the large variety of tools for yourselves.



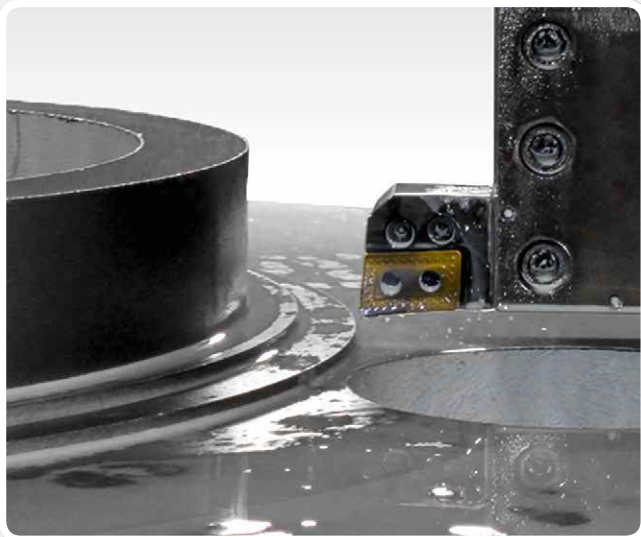

Les outils coupants Ingersoll offre une large variété de solutions de tournage et perçage pour une production toujours plus efficace. Que ce soit en solution standard ou en solution spéciale - Avec les outils coupants Ingersoll, vous prenez une longueur d'avance.

Ingersoll a un savoir faire considérable afin d'assurer vos opérations de tournage, perçage et alésage. Utilisez nos outils-coupants à travers un large choix d'outils selon vos besoins.

CUSTOMERS - INTENSIFY CONTACTS



Ingersoll Werkzeuge is present all over the world - at tool shows and congresses of the milling and machine tool industry as well as at house exhibitions of leading machine tool manufacturers.

To intensify the direct contact to our customers, we organize special seminars and application-specific training courses in our customer centers in Haiger and Horrheim/Germany and Rockford/USA.

Current dates and up-to-date information on our seminars are stated under: www.ingersoll-imc.de and www.ingersoll-imc.com



NOS CLIENTS - INTENSIFIER LES CONTACTS



Ingersoll Werkzeuge GmbH est présent dans le monde entier lors de salons et congrès sur l'industrie du fraisage et de la machine-outil, ainsi qu'aux portes ouvertes des fabricants leader en machines.

Pour assurer les relations directes avec nos clients, nous organisons des séminaires et des formations sur des applications spécifiques dans nos centres techniques de Haiger/Allemagne et Rockford/USA.

Les dates et informations utiles sur nos séminaires sont disponibles sur: www.ingersoll-imc.fr



Ingersoll is a worldwide operating manufacturer of milling, boring, threading and turning tools for demanding machining operations.

Our main production plants in Haiger and Horrheim in Germany as well as Rockford in the United States, supply customers all over the world. Experienced and well-trained representatives in over 45 countries ensure a network of on-site advice and assistance. Ingersoll's complete range of performance and service is available to our customers – all over the world.



Marketing office Haiger (Germany)



Marketing office Rockford (USA)

Ingersoll est un fabricant mondial d'outils coupants destinés aux opérations de fraisage et tournage.

Nos principaux sites de fabrication, à Haiger et à Horrheim en Allemagne ainsi qu'à Rockford aux USA, fournissent nos clients dans le monde entier. Dans plus de 45 pays, nos représentants expérimentés et formés à notre technologie, constituent un réseau d'assistance et de conseils sur site. La gamme complète de produits performants et services Ingersoll est accessible à nos clients -partout dans le monde.

Ingersoll Cutting Tools

Marketing- & Technology

Germany / Allemagne

Ingersoll Werkzeuge GmbH

Kalteiche-Ring 21-25

35708 Haiger, Germany

Tel.: +49 (0)2773-742-0

Fax: +49 (0)2773-742-812/814

E-Mail: info@ingersoll-imc.de

Internet: www.ingersoll-imc.de

USA

Ingersoll Cutting Tools

845 S. Lyford Road

Rockford, Illinois 61108-2749, USA

Tel.: +1-815-387-6600

Fax: +1-815-387-6968

E-Mail: info@ingersoll-imc.com

Internet: www.ingersoll-imc.com

France

Ingersoll France

22, Rue Albert Einstein

F-77420 CHAMPS-sur-MARNE

Tel.: +33 (0) 1 64 68 45 36

Fax: +33 (0) 1 64 68 45 24

E-Mail: info@ingersoll-imc.fr

Internet: www.ingersoll-imc.fr

